

texi®

*B&White
Black*



▶▶▶ *dedicated to true lover of sewing*

główne funkcje:

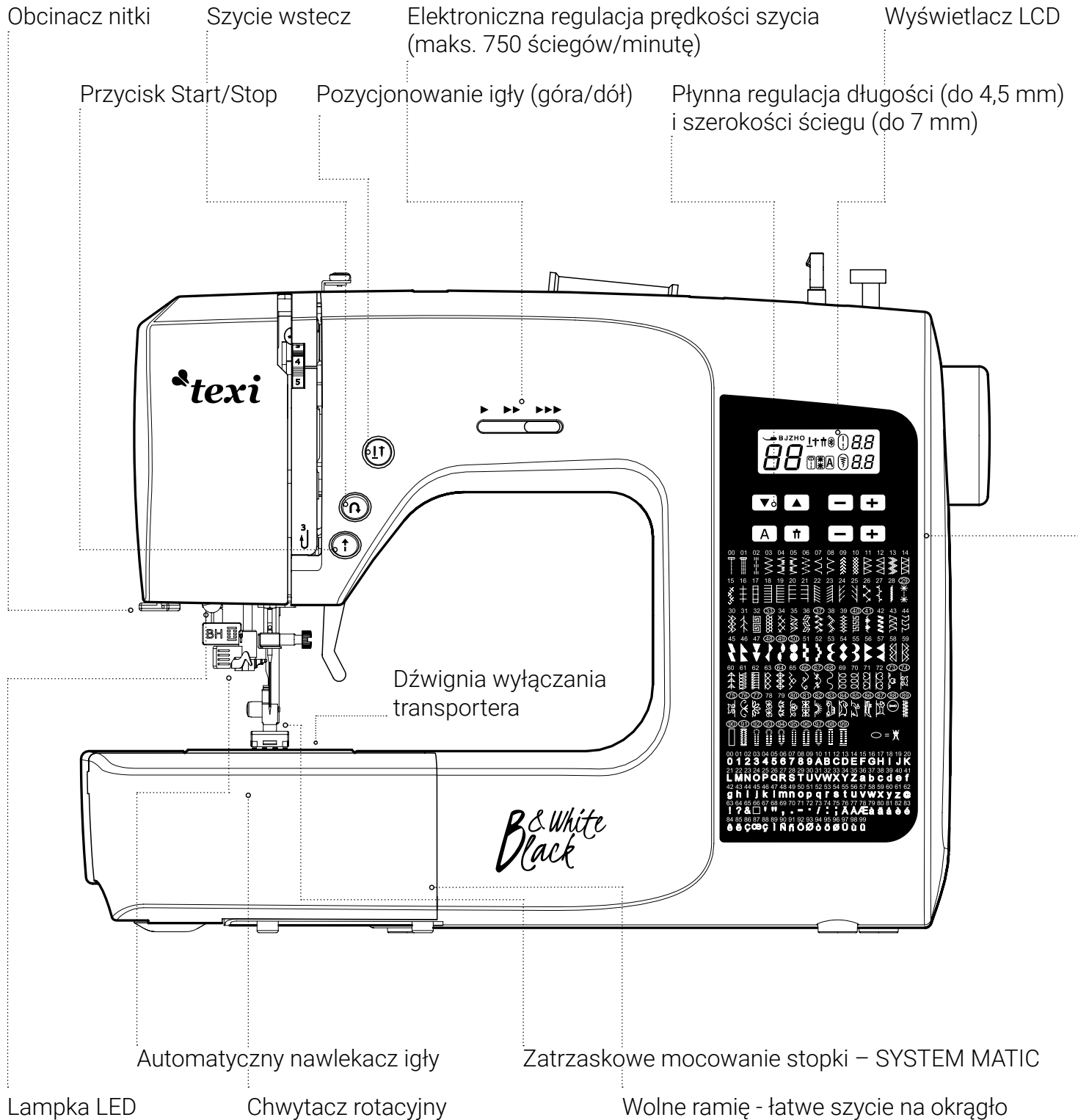

►►► *dedicated to true lover of sewing*



200 programów szycia (m.in. 9 rodzajów automatycznego obszywania dziurki, ściegi proste, zygzaki, owerlokowe, elastyczne i ozdobne, alfabet)

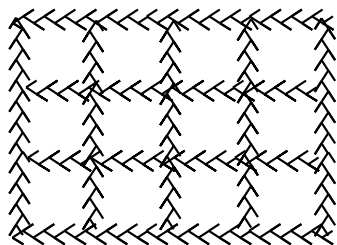

Patchwork

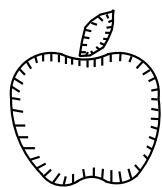

Aplikacje

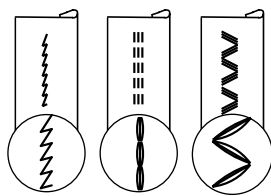

Ściegi elastyczne

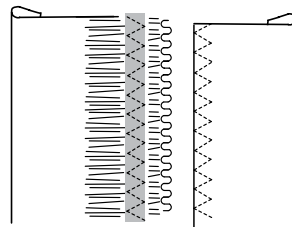

Zygzaki

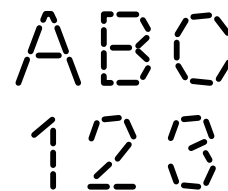

Alfabet, cyfry

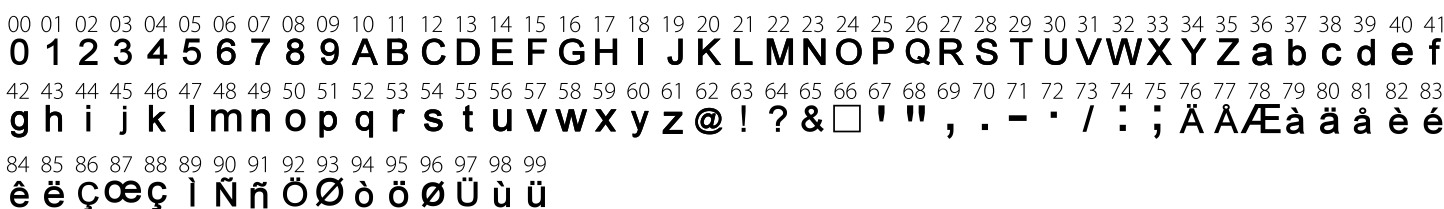
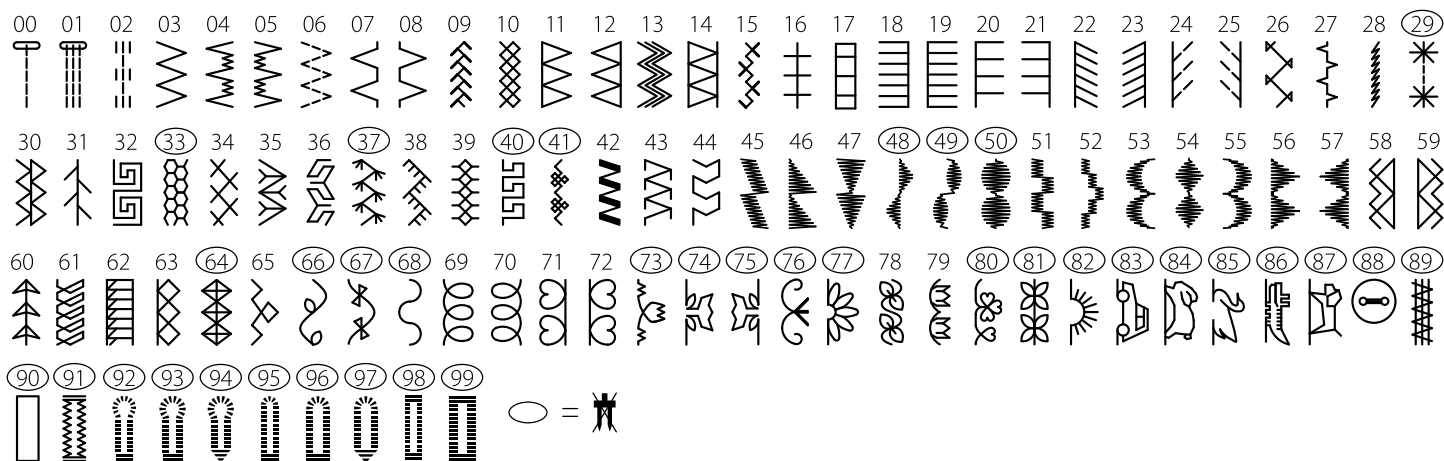

akcesoria w zestawie:

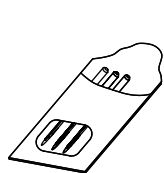

Zestaw igieł

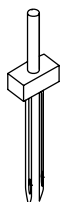

Igła podwójna

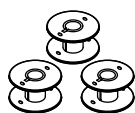

3 szpulki

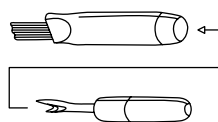

Rozcinacz dziurek ze szczotką

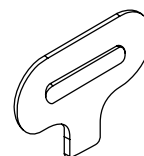

Śrubokręt do płytki ścięgowej

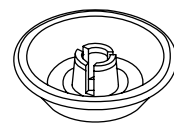

Uchwyt zabezpieczający szpulkę

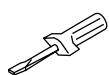

Śrubokręt

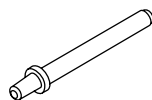

Szпульka

Rozrusznik nożny (pedał)
Miękki pokrowiec

zawiera zestaw szybkowymiennych
stoppek SYSTEM MATIC

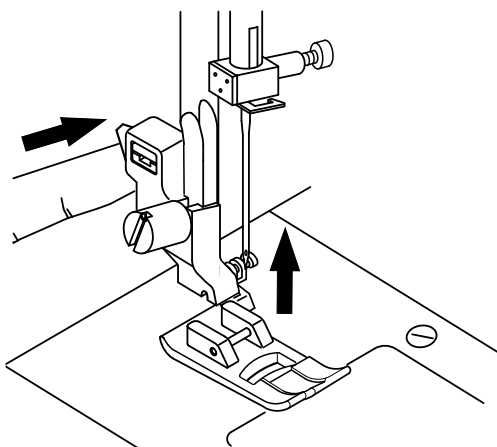

stopki w zestawie:

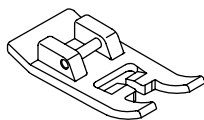

Stopka do ściegów
ozdobnych

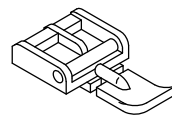

Stopka
do wszywania
zamków

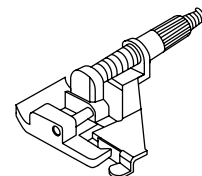

Stopka
do podszywania
(ścieg kryty)

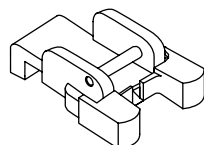

Stopka
do przyszywania
guzików

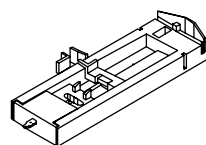

Stopka do
obszywania dziurek

Stopka
uniwersalna

polecamy również:

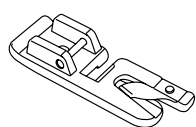

stopka MATIC
podwójnie
zwijająca
TEXI 1010



stopka
do zszywania
i marszczenia
TEXI 0010

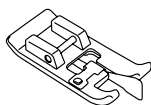

stopka MATIC
do ściegu
overlokowego
TEXI 1013

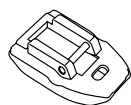

stopka MATIC
do wszywania
zamków krytych
TEXI 1015

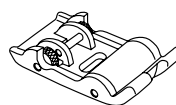

stopka MATIC
z rolkami do trudnych
materiałów
TEXI 1016

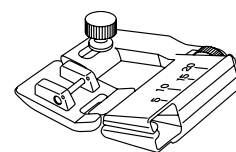

stopka MATIC
do wszywania
zaprasowanej lamówki
TEXI 1017

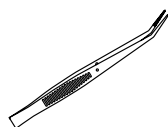

pinceta
TEXI 4005

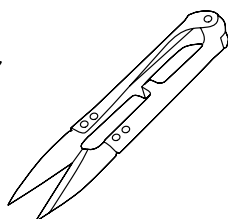

obcinaczki do nitki
TEXI 4022

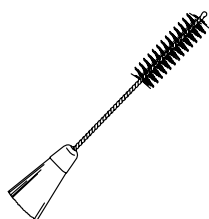

pędzelek
do czyszczenia maszyn
TEXI 4017

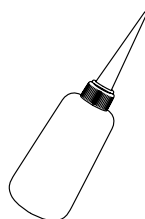

oliwiarka 125 ml
TEXI 4027

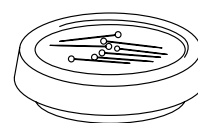

magnetyczna poduszka
do igieł i szpilek
TEXI 4029

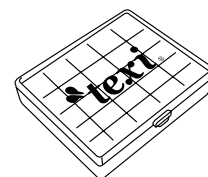

pudefko
na 25 szpulek
TEXI 4033